

# DFNWB2X2-6L-A Plastic-Encapsulate MOSFETS

## CJMP06 P-Channel Power MOSFET

DFNWB2\*2-6L-A

$V_{(BR)DSS}$	$R_{DS(on)MAX}$	$I_D$
-20V	110mΩ@-4.5V	-2A
	150mΩ@-2.5V	

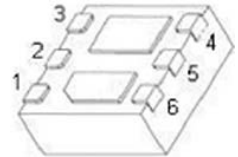

### FEATURE

- Featuring a MOSFET and Schottky Diode
- Independent Pinout to each Device to Ease Circuit Design
- Ultra Low  $V_F$  Schottky

### APPLICATIONS

- Li-Ion Battery Charging
- High Side DC-DC Conversion Circuits
- High Side Device for Small Brushless DC Motors
- Power Managemnet in Portable , Battery Powered Products

### MARKING:



front



back

### Equivalent Circuit

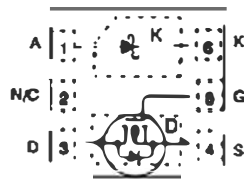

### MOSFET MAXIMUM RATINGS ( $T_a=25^\circ\text{C}$ unless otherwise noted)

Parameter	Symbol	Value	Unit
Drain-Source Voltage	$V_{DS}$	-20	V
Gate-Source Voltage	$V_{GS}$	$\pm 8$	V
Continuous Drain Current	$I_D$	-2	A
Power Dissipation	$P_D$	0.7	W
Thermal Resistance from Junction to Ambient	$R_{\theta JA}$	178	$^\circ\text{C/W}$
Storage Temperature	$T_j$	150	
Junction Temperature	$T_{jop}$	-55 ~ +150	

# MOSFET ELECTRICAL CHARACTERISTICS

$T_a=25^\circ\text{C}$  unless otherwise specified

Parameter	Symbol	Test Condition	Min	Typ	Max	Unit
<b>On/Off Characteristics</b>						
Drain-source breakdown voltage	$V_{(BR)DSS}$	$V_{GS} = 0V, I_D = -250\mu A$	-20			V
Gate-threshold voltage	$V_{GS(th)}$	$V_{DS} = V_{GS}, I_D = -250\mu A$	-0.4		-1	
Gate-body leakage current	$I_{GBS}$	$V_{DS} = 0V, V_{GS} = \pm 8V$			$\pm 100$	nA
Zero gate voltage drain current	$I_{DSS}$	$V_{DS} = -20V, V_{GS} = 0V$			-1	$\mu A$
Drain-source on-state resistance (note 1)	$R_{DS(on)}$	$V_{GS} = -4.5V, I_D = -2.8A$			110	m $\Omega$
		$V_{GS} = -2.5V, I_D = -2.0A$			150	
Forward transconductance (note 1)	$g_{fs}$	$V_{DS} = -10V, I_D = -2.7A$	5.5			S
<b>Charges , Capacitances and Gate resistance</b>						
Input capacitance (note 2)	$C_{iss}$	$V_{DS} = -15V, V_{GS} = 0V, f = 1\text{MHz}$		480		pF
Output capacitance (note 2)	$C_{oss}$			46		
Reverse transfer capacitance (note 2)	$C_{rss}$			10		
Total gate charge	$Q_g$	$V_{DS} = -8V, V_{GS} = -4.5V, I_D = -2.8A$		7.2		nC
Gate-source charge	$Q_{gs}$			2.2		
Gate-drain charge	$Q_{gd}$			1.2		
<b>Switching times (note2)</b>						
Turn-on delay time	$t_{d(on)}$	$V_{DS} = -8V, R_L = 8\Omega$ $V_{GS} = -4.5V, R_{GDN} = 8\Omega$		38		ns
Rise time	$t_r$			25		
Turn-off delay time	$t_{d(off)}$			43		
Fall time	$t_f$			5		
<b>Source-drain diode characteristics</b>						
Forward on voltage (note1)	$V_{SD}$	$V_{GS} = 0V, I_S = -1A$			-1.4	V

Notes:

1. Pulse Test : Pulse width  $\leq 300\mu s$ , duty cycle  $\leq 2\%$ .
2. These parameters have no way to verify.

## SCHOTTKY DIODE MAXIMUM RATINGS ( $T_a=25^\circ\text{C}$ unless otherwise noted)

Parameter Symbol		Value	Unit
Peak Repetitive Reverse Voltage	$V_{RRM}$	20	V
DC blocking voltage	$V_R$	20	
Average rectified forward current	$I_F$	1	A

## SCHOTTKY DIODE ELECTRICAL CHARACTERISTICS ( $T_a=25^\circ\text{C}$ unless otherwise noted)

Parameter	Symbol	Test Condition	Min	Typ	Max	Unit
Forward voltage	$V_F$	$I_F = 0.1A$			0.4	
		$I_F = 0.5A$			0.5	
		$I_F = 1A$			0.575	
Reverse current	$I_R$	$V_R = 20V$			15	$\mu A$
		$V_R = 10V$			5	

## Typical Characteristics

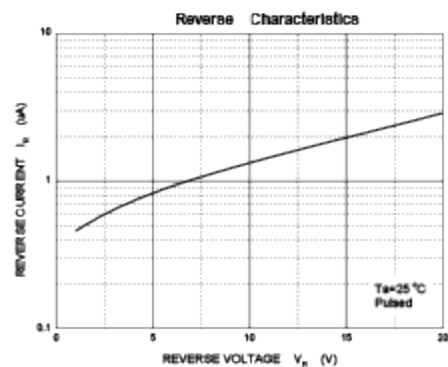
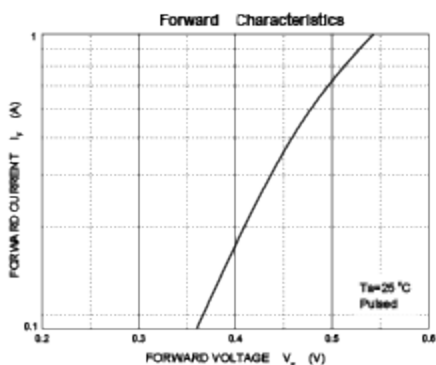
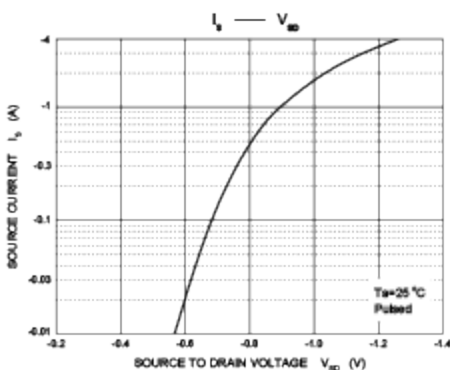
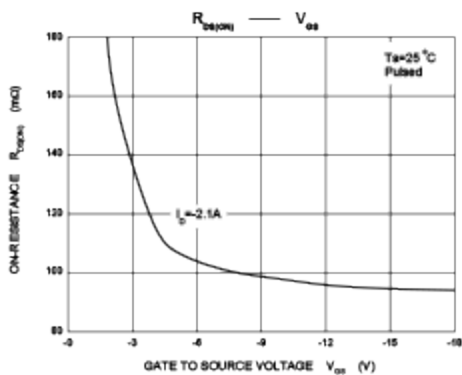
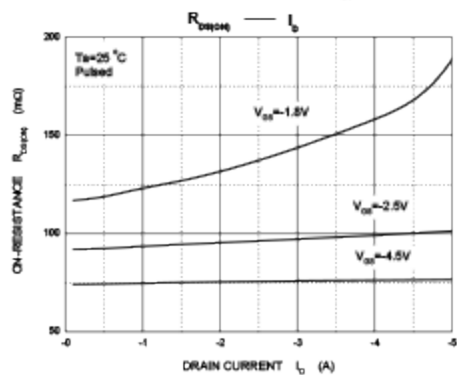
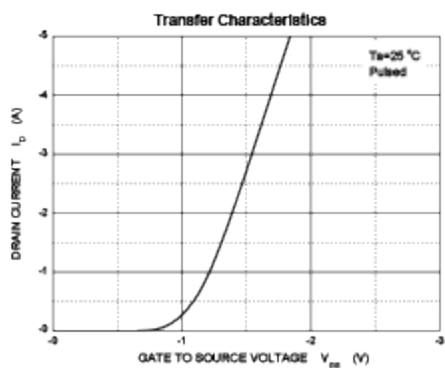
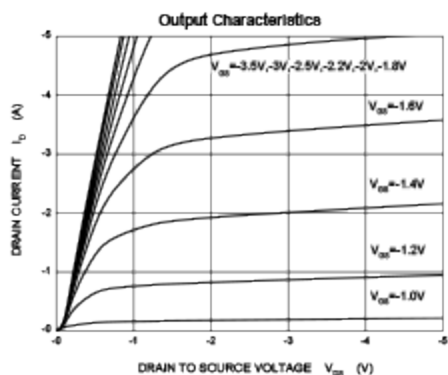

## DFNWB2X2-6L-A Package Outline Dimensions

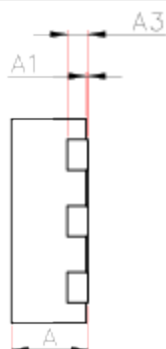
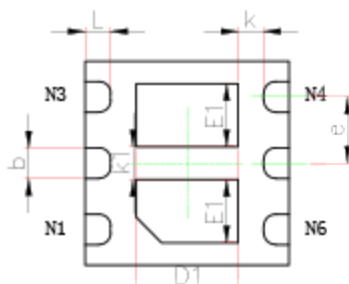
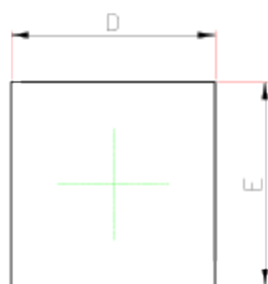

Symbol	Dimensions In Millimeters		Dimensions In Inches	
	MIN.	MAX.	MIN.	MAX.
A	0.700	0.800	0.028	0.031
A1	0.000	0.060	0.000	0.002
A3	0.203REF.		0.008REF.	
D	1.900	2.100	0.075	0.083
E	1.900	2.100	0.075	0.083
D1	0.900	1.100	0.035	0.043
E1	0.520	0.720	0.020	0.028
b	0.250	0.350	0.010	0.014
e	0.650TYP.		0.026TYP.	
k	0.200MIN.		0.008MIN.	
k1	0.320REF.		0.013REF.	
L	0.200	0.300	0.008	0.012

## DFNWB2X2-6L-A Suggested Pad Layout

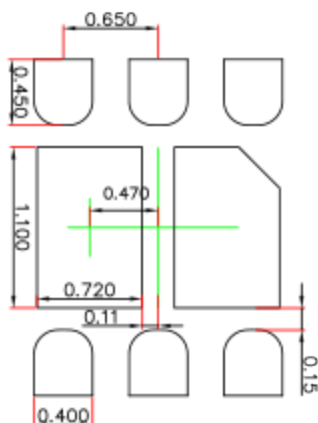

### Note:

1. Controlling dimension: in millimeters.
2. General tolerance:  $\pm 0.050\text{mm}$ .
3. The pad layout is for reference purposes only.

### NOTICE

JCET reserve the right to make modifications, enhancements, improvements, corrections or other changes without further notice to any product herein. JCET does not assume any liability arising out of the application or use of any product described herein.

## DFNWB2X2-6L Tape and Reel

### DFNWB2×2-6L Embossed Carrier Tape

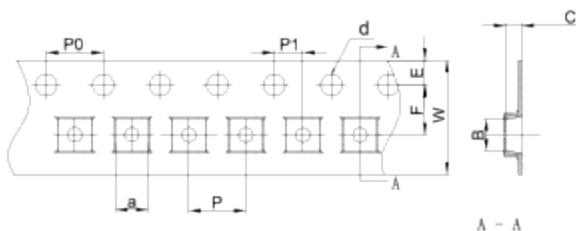

#### Packaging Description:

DFNWB2×2-6L parts are shipped in tape. The carrier tape is made from a dissipative (carbon filled) polycarbonate resin. The cover tape is a multilayer film (Heat Activated Adhesive in nature) primarily composed of polyester film, adhesive layer, sealant, and anti-static sprayed agent. These reeled parts in standard option are shipped with 3,000 units per 7" or 18.0cm diameter reel. The reels are clear in color and is made of polystyrene plastic (anti-static coated).

Dimensions are in millimeter

Pkg type	a	B	C	d	E	F	P0	P	P1	W
DFNWB2×2-6L	2.30	2.30	1.10	Ø1.50	1.75	3.50	4.00	4.00	2.00	8.00

### DFNWB2×2-6L Tape Leader and Trailer

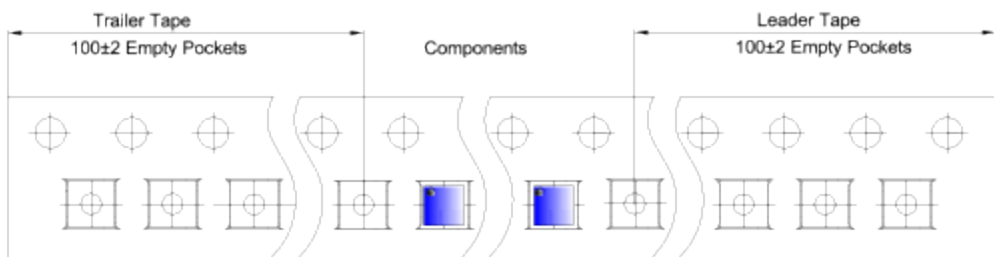

### DFNWB2×2-6L Reel

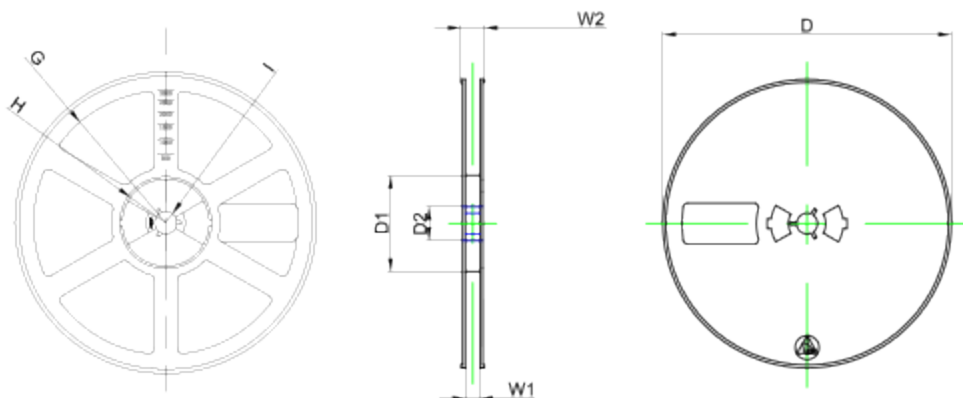

Dimensions are in millimeter

Reel Option	D	D1	D2	G	H	I	W1	W2
7" Dia	Ø180.00	60.00	13.00	R78.00	R25.60	R6.50	9.50	13.10

REEL	Reel Size	Box	Box Size(mm)	Carton	Carton Size(mm)	G.W.(kg)
3000 pcs	7 inch	30,000 pcs	203×203×195	120,000 pcs	438×438×220	