

## SOT-323 PACKAGE OUTLINE DIMENSIONS

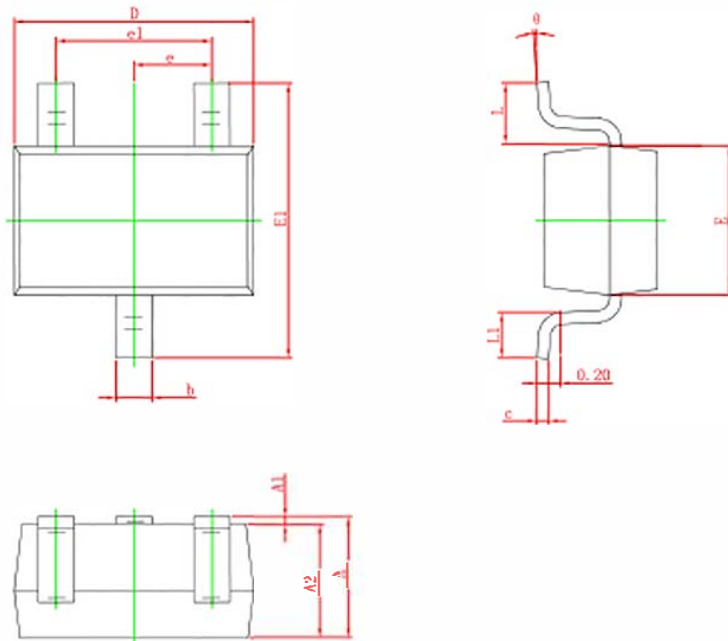

| Symbol   | Dimensions In Millimeters |       | Dimensions In Inches |       |
|----------|---------------------------|-------|----------------------|-------|
|          | Min.                      | Max.  | Min.                 | Max.  |
| A        | 0.900                     | 1.100 | 0.035                | 0.043 |
| A1       | 0.000                     | 0.100 | 0.000                | 0.004 |
| A2       | 0.900                     | 1.000 | 0.035                | 0.039 |
| b        | 0.200                     | 0.400 | 0.008                | 0.016 |
| c        | 0.080                     | 0.150 | 0.003                | 0.006 |
| D        | 2.000                     | 2.200 | 0.079                | 0.087 |
| E        | 1.150                     | 1.350 | 0.045                | 0.053 |
| E1       | 2.150                     | 2.450 | 0.085                | 0.096 |
| e        | 0.650 TYP.                |       | 0.026 TYP.           |       |
| e1       | 1.200                     | 1.400 | 0.047                | 0.055 |
| L        | 0.525 REF.                |       | 0.021 REF.           |       |
| L1       | 0.260                     | 0.460 | 0.010                | 0.018 |
| $\theta$ | 0°                        | 8°    | 0°                   | 8°    |

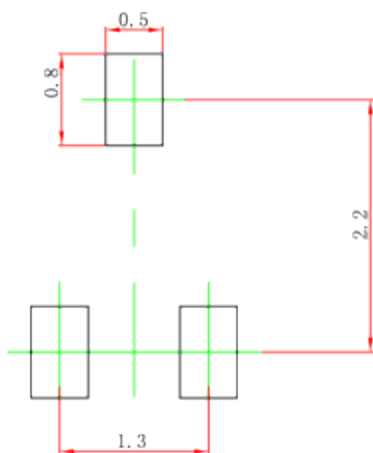

中心距: 1.30  
 脚宽: 0.30  
 焊盘宽: 0.50  
 脚长: 0.53  
 焊盘长: 0.80

技术要求

1. 塑封体尺寸 $2.10 \times 1.25$ ;
2. 未注公差为:  $\pm 0.05$ ;
3. 所有单位为: mm.

媒体编号

镀涂

旧底图总号

SOT-323  
焊盘

底图总号

| 更改标记 | 数量 | 更改单号 | 签名 | 日期 |
|------|----|------|----|----|
| 设计   |    |      |    |    |
| 审核   |    |      |    |    |
| 工艺   |    |      |    |    |

等级标记

版号

比例

20:1

日期

签名

第 1 张 共 1 张

标准化  
批准

江苏长电科技股份有限公司

格式 (1)

制图:

插图:

幅面: A4

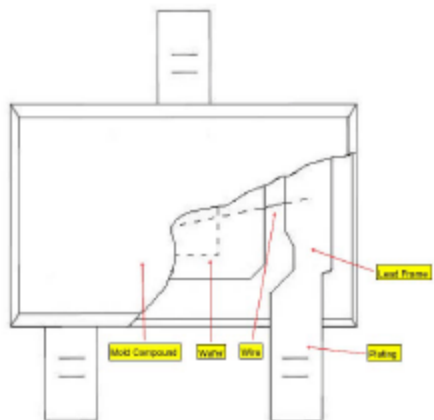

## SOT-323 Tape and reel

### SOT-323 Embossed Carrier Tape

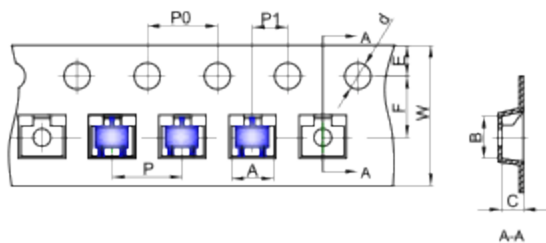

#### Packaging Description:

SOT-323 parts are shipped in tape. The carrier tape is made from a dissipative (carbon filled) polycarbonate resin. The cover tape is a multilayer film (Heat Activated Adhesive in nature) primarily composed of polyester film, adhesive layer, sealant, and anti-static sprayed agent. These reeled parts in standard option are shipped with 3,000 units per 7" or 17.8cm diameter reel. The reels are clear in color and is made of polystyrene plastic (anti-static coated).

Dimensions are in millimeter

| Plg type    | A       | B       | C       | d      | E      | F      | P0     | P      | P1     | W         |
|-------------|---------|---------|---------|--------|--------|--------|--------|--------|--------|-----------|
| SOT-323     | 2.25    | 2.55    | 1.19    | Ø1.55  | 1.75   | 3.50   | 4.00   | 4.00   | 2.00   | 8.00      |
| (Tolerance) | +/-0.05 | +/-0.05 | +/-0.05 | +/-0.1 | +/-0.1 | +/-0.1 | +/-0.1 | +/-0.1 | +/-0.1 | +0.3/-0.1 |

### SOT-323 Tape Leader and Trailer

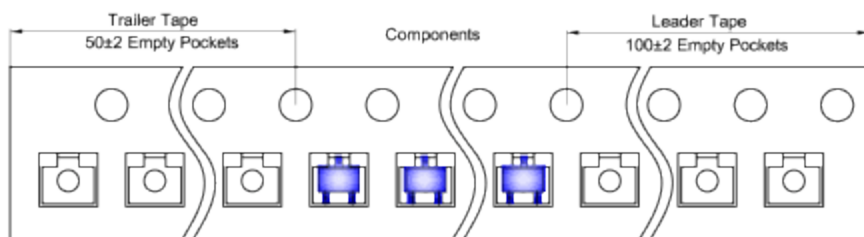

### SOT-323 Reel

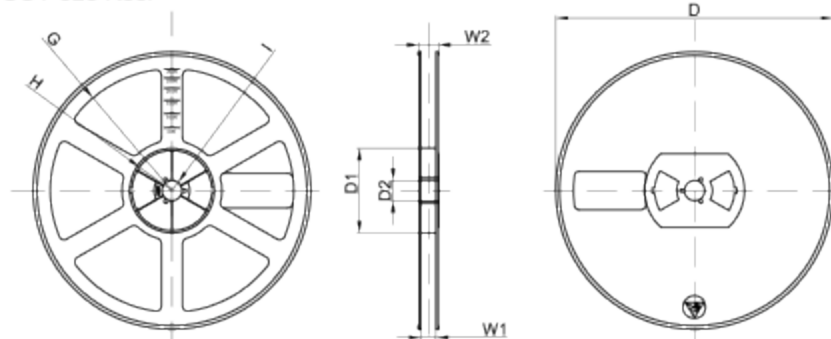

Dimensions are in millimeter

| Reel Option | D       | D1    | D2    | G      | H      | I     | W1   | W2    |
|-------------|---------|-------|-------|--------|--------|-------|------|-------|
| 7" Dia      | Ø178.00 | 54.40 | 13.00 | R78.00 | R25.50 | R6.50 | 9.50 | 12.30 |
| Tolerance   | +/-2    | +/-1  | +/-1  | +/-1   | +/-1   | +/-1  | +/-1 | +/-1  |

| REEL     | Reel Size | Box        | Box Size(mm) | Carton      | Carton Size(mm) | G.W.(kg) |
|----------|-----------|------------|--------------|-------------|-----------------|----------|
| 3000 pcs | 7 Inch    | 45,000 pcs | 203×203×195  | 180,000 pcs | 438×438×220     |          |



The bottom gasket

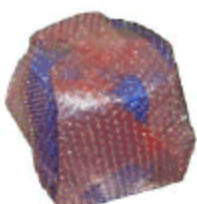
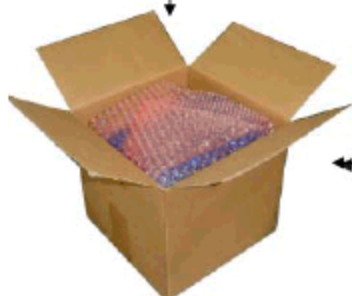

3000 × 15 PCS

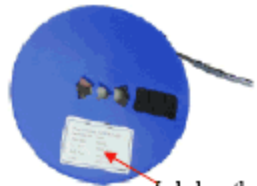

Label on the Reel

3000 × 1 PCS



The top gasket



Seal the box with the tape

Label on the Inner Box

Inner Box: 203mm × 203mm × 195mm

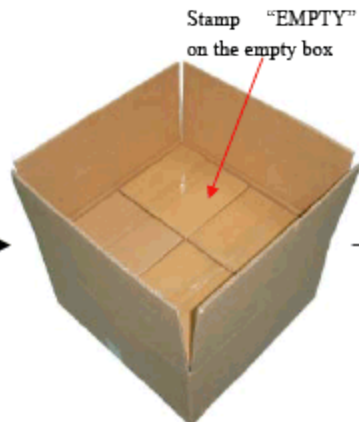

Stamp "EMPTY" on the empty box

Seal the box with the tape

QA Label

Label on the Outer Box

Outer Box: 438mm × 438mm × 220mm