

## SOT-563 Plastic-Encapsulate Transistors

### EMT1 DUAL TRANSISTOR(PNP+PNP)

#### FEATURES

- Two 2SA1037AK chips in a package
- Mounting possible with SOT-563 automatic mounting machines
- Transistor elements are independent,eliminating interference

Marking: T1

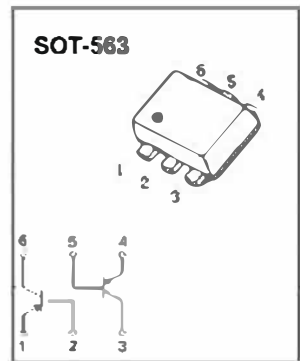

Absolute maximum ratings ( $T_a=25^{\circ}\text{C}$ )

Symbol	Parameter	Value	Units
$V_{CB0}$	Collector-Base Voltage	-60	V
$V_{CE0}$	Collector-Emitter Voltage	-50	V
$V_{EB0}$	Emitter-Base Voltage	-6	V
$I_C$	Collector Current	-150	mA
$P_C$	Collector Power Dissipation	150	mW
$T_J$	Junction Temperature	150	$^{\circ}\text{C}$
$T_{stg}$	Storage Temperature	-55-150	$^{\circ}\text{C}$

ELECTRICAL CHARACTERISTICS ( $T_a=25^{\circ}\text{C}$  unless otherwise specified)

Parameter	Symbol	Test conditions	Min	Typ	Max	Unit
Collector-base breakdown voltage	$V_{(BR)CB0}$	$I_C=-50\mu\text{A}, I_E=0$	-60			V
Collector-emitter breakdown voltage	$V_{(BR)CE0}$	$I_C=-1\text{mA}, I_B=0$	-50			V
Emitter-base breakdown voltage	$V_{(BR)EB0}$	$I_E=-50\mu\text{A}, I_C=0$	-6			V
Collector cut-off current	$I_{CB0}$	$V_{CB}=-60\text{V}, I_E=0$			-0.1	$\mu\text{A}$
Emitter cut-off current	$I_{EB0}$	$V_{EB}=-7\text{V}, I_C=0$			-0.1	$\mu\text{A}$
DC current gain	$h_{FE}$	$V_{CE}=-6\text{V}, I_C=1\text{mA}$	120		560	
Collector-emitter saturation voltage	$V_{CE(sat)}$	$I_C=-50\text{mA}, I_B=5\text{mA}$			-0.5	V
Transition frequency	$f_T$	$V_{CE}=-12\text{V}, I_C=-2\text{mA}, f=100\text{MHz}$		140		MHz
Output capacitance	$C_{e0}$	$V_{CB}=-12\text{V}, I_E=0, f=1\text{MHz}$			5	pF

# Typical Characteristics

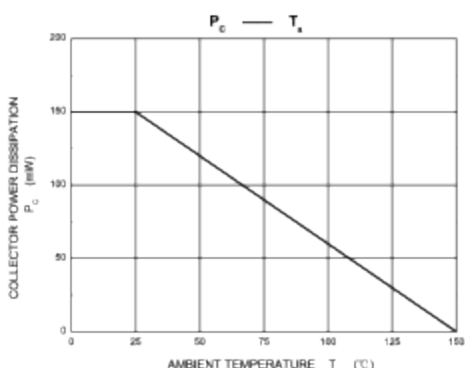
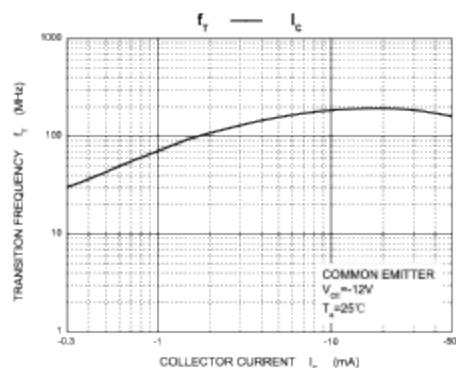
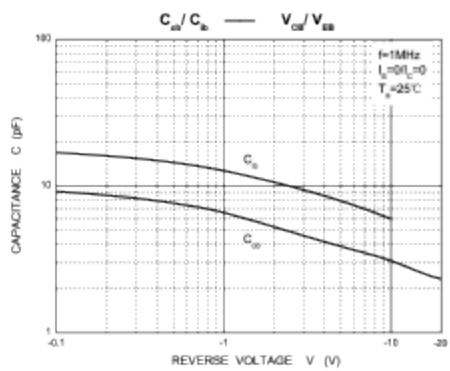
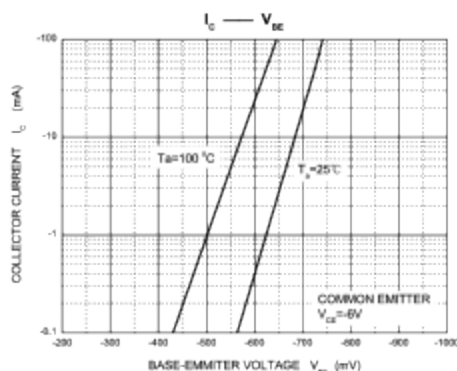
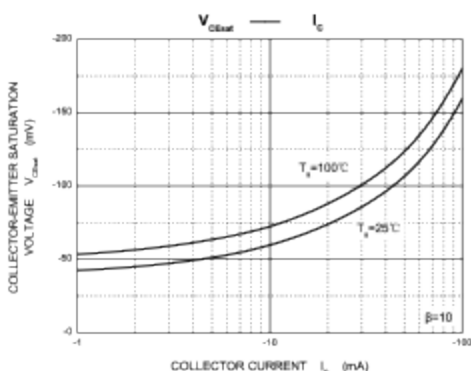
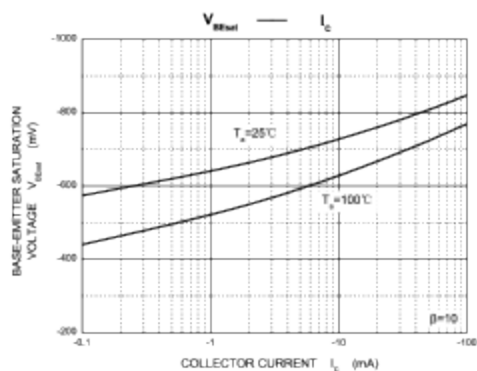
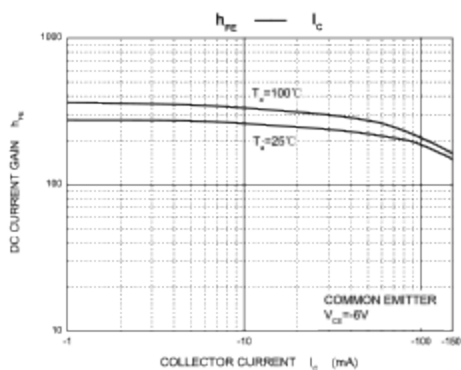
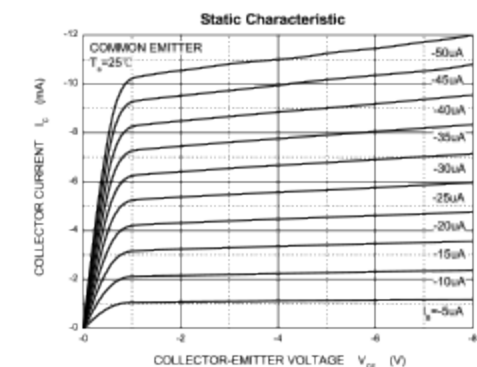

## SOT-563 Package Outline Dimensions

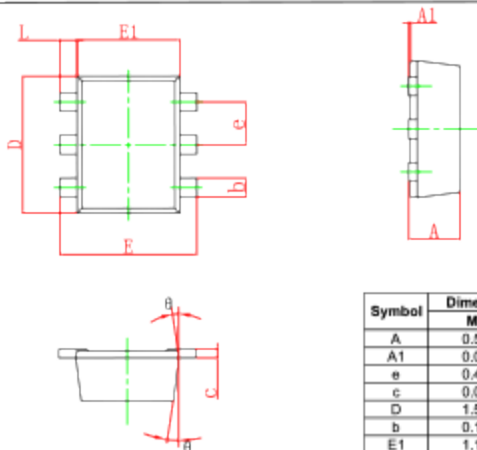

Symbol	Dimensions in Millimeters		Dimensions in Inches	
	Min.	Max.	Min.	Max.
A	0.525	0.600	0.021	0.024
A1	0.000	0.050	0.000	0.002
e	0.450	0.550	0.018	0.022
c	0.090	0.160	0.004	0.006
D	1.500	1.700	0.059	0.067
b	0.170	0.270	0.007	0.011
E1	1.100	1.300	0.043	0.051
E	1.500	1.700	0.059	0.067
L	0.100	0.300	0.004	0.012
B	7° REF.		7° REF.	

## SOT-563 Suggested Pad Layout

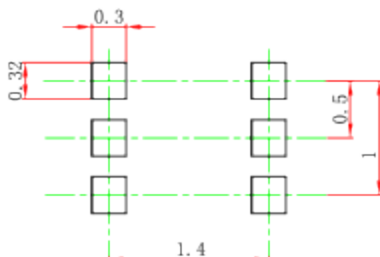

Note:

1. Controlling dimension in millimeters.
2. General tolerance:  $\pm 0.05\text{mm}$ .
3. The pad layout is for reference purposes only.

### NOTICE

JCET reserve the right to make modifications, enhancements, improvements, corrections or other changes without further notice to any product herein. JCET does not assume any liability arising out of the application or use of any product described herein.

# SOT-563 Tape and reel

## SOT-563 Embossed Carrier Tape

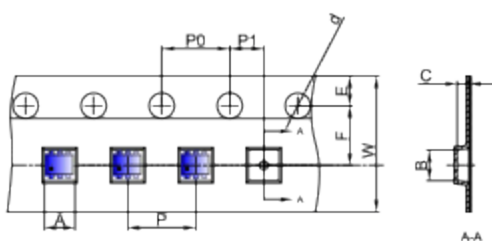

### Packaging Description:

SOT-563 parts are shipped in tape. The carrier tape is made from a dissipative (carbon filled) polycarbonate resin. The cover tape is a multilayer film (Heat Activated Adhesive in nature) primarily composed of polyester film, adhesive layer, sealant, and anti-static sprayed agent. These reeled parts in standard option are shipped with 3,000 units per 7" or 17.8cm diameter reel. The reels are clear in color and is made of polystyrene plastic (anti-static coated).

Dimensions are in millimeter										
Pkg type	A	B	C	d	E	F	P0	P	P1	W
SOT-563	1.78	1.78	0.69	Ø1.50	1.75	3.50	4.00	4.00	2.00	8.00
(Tolerance)	+/-0.1	+/-0.1	+/-0.1	+/-0.1	+/-0.1	+/-0.1	+/-0.1	+/-0.1	+/-0.1	+/-0.1

## SOT-563 Tape Leader and Trailer

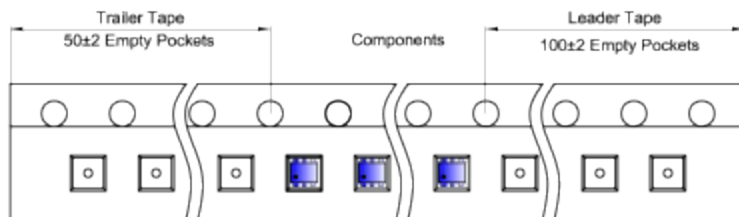

## SOT-563 Reel

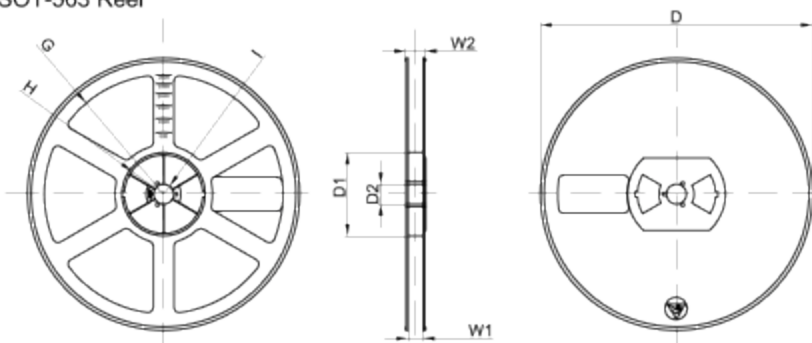

Dimensions are in millimeter								
Reel Option	D	D1	D2	G	H	I	W1	W2
7" Dia	Ø178.00	54.40	13.00	R78.00	R25.60	R6.50	9.50	12.30
Tolerance	+/-2	+/-1	+/-1	+/-1	+/-1	+/-1	+/-1	+/-1

REEL	Reel Size	Box	Box Size(mm)	Carton	Carton Size(mm)	G.W.(kg)
3000 pcs	7 inch	45,000 pcs	203×203×195	180,000 pcs	438×438×220	