

# SOP8 Plastic-Encapsulate MOSFETS

## CJ4803A Dual P-Channel 30-V(D-S) MOSFET

$V_{(BR)DSS}$	$R_{DS(on)MAX}$	$I_D$
-30V	46mΩ@-10V	-5A
	74mΩ@-4.5V	

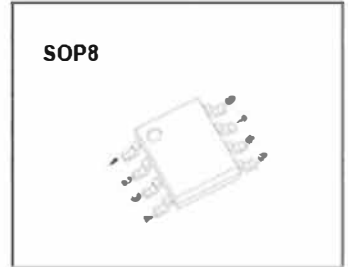

### DESCRIPTION

The CJ4803A uses advanced trench technology to provide excellent  $R_{DS(on)}$ . This device is suitable for use as a load switch or in PWM applications.

### MARKING

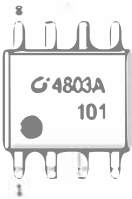

### Equivalent Circuit

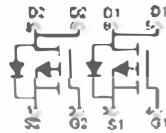

Maximum ratings ( $T_a=25^{\circ}\text{C}$  unless otherwise noted)

Parameter	Symbol	Value	Unit
Drain-source voltage	$V_{DS}$	-30	V
Gate-source voltage	$V_{GS}$	$\pm 20$	
Continuous drain current	$I_D$	-5	A
Pulsed drain current	$I_{DM}$	-30	
Maximum body-diode continuous current	$I_S$	-2	
Power dissipation	$P_D$	0.35	W
Thermal resistance from junction to ambient	$R_{\theta JA}$	357	$^{\circ}\text{C/W}$
Junction temperature	$T_J$	150	$^{\circ}\text{C}$
Storage temperature	$T_{stg}$	-55 ~ +150	

## MOSFET ELECTRICAL CHARACTERISTICS

$T_a=25^\circ\text{C}$  unless otherwise specified

Parameter	Symbol	Test Condition	Min	Typ	Max	Unit
STATIC PARAMETERS						
Drain-source breakdown voltage	$V_{(BR)DSS}$	$V_{GS}=0V, I_D=-250\mu A$	-30			V
Gate-source leakage	$I_{OSS}$	$V_{DS}=0V, V_{GS}=\pm 20V$			$\pm 100$	nA
Zero gate voltage drain current	$I_{DSS}$	$V_{DS}=-30V, V_{GS}=0V$			-1.0	$\mu A$
Gate-source threshold voltage	$V_{GS(th)}$	$V_{DS}=V_{GS}, I_D=-250\mu A$	-1.5	-2	-2.5	V
Drain-source On-State resistance	$R_{DS(on)}$	$V_{GS}=-10V, I_D=-5.0A$		37	48	m $\Omega$
		$V_{GS}=-4.5V, I_D=-4A$		60	74	
Forward diode voltage	$V_{SD}$	$V_{GS}=0V, I_S=-1A$		-0.77	-1	V
Forward transconductance	$g_{FS}$	$V_{DS}=-5V, I_D=-5A$	10			S
DYNAMIC PARAMETERS						
Input capacitance	$C_{iss}$	$V_{DS}=-15V, V_{GS}=0V, f=1\text{MHz}$	830			pF
Output capacitance	$C_{oss}$			128		
Reverse transfer capacitance	$C_{riss}$			92		
SWITCHING PARAMETERS						
Turn-on delay time	$t_{d(on)}$	$V_{GS}=-10V, V_{DS}=-15V,$ $R_L=3\Omega, R_{GEN}=3\Omega$		7.7		ns
Rise time	$t_r$			6.8		
Turn-off delay time	$t_{d(off)}$			20		
Fall time	$t_f$			10		

## SOP8 Package Outline Dimensions

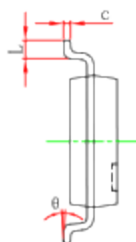
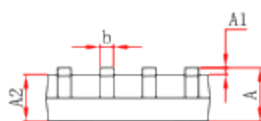
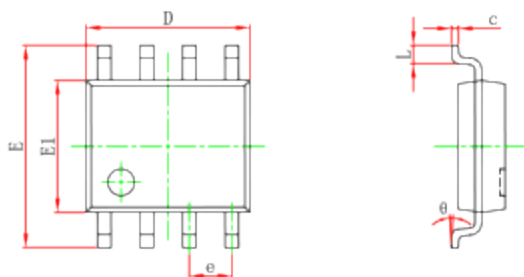

Symbol	Dimensions In Millimeters		Dimensions In Inches	
	Min	Max	Min	Max
A	1.350	1.750	0.053	0.069
A1	0.100	0.250	0.004	0.010
A2	1.350	1.550	0.053	0.061
b	0.330	0.510	0.013	0.020
c	0.170	0.250	0.007	0.010
D	4.800	5.000	0.189	0.197
e	1.270 (BSC)		0.050 (BSC)	
E	5.800	6.200	0.228	0.244
E1	3.800	4.000	0.150	0.157
L	0.400	1.270	0.016	0.050
theta	0°	8°	0°	8°

## SOP8 Suggested Pad Layout

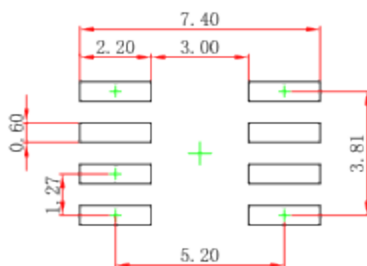

### Note:

1. Controlling dimension: in millimeters.
2. General tolerance:  $\pm 0.05\text{mm}$ .
3. The pad layout is for reference purposes only.

### NOTICE

JCET reserve the right to make modifications, enhancements, improvements, corrections or other changes without further notice to any product herein. JCET does not assume any liability arising out of the application or use of any product described herein.

## SOP8 Tape and Reel

### SOP8 Embossed Carrier Tape

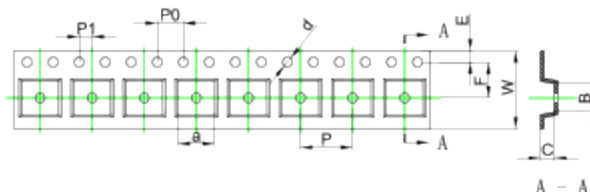

#### Packaging Description:

SOP8 parts are shipped in tape. The carrier tape is made from a dissipative (carbon filled) polycarbonate resin. The cover tape is a multilayer film (Heat Activated Adhesive in nature) primarily composed of polyester film, adhesive layer, sealant, and anti-static sprayed agent. These reeled parts in standard option are shipped with 2,500 units per 13" or 33cm diameter reel. The reels are clear in color and is made of polystyrene plastic (anti-static coated).

ALL DIM IN mm

Dimensions are in millimeter										
Pkg type	a	B	C	d	E	F	P0	P	P1	W
SOP8	6.40	5.40	2.10	Ø1.50	1.75	5.50	4.00	8.00	2.00	12.00

### SOP8 Tape Leader and Trailer

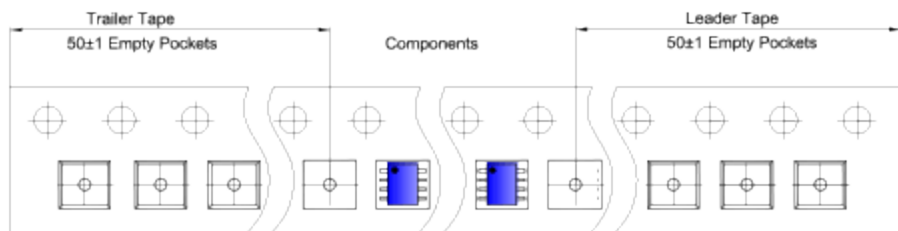

### SOP8 Reel

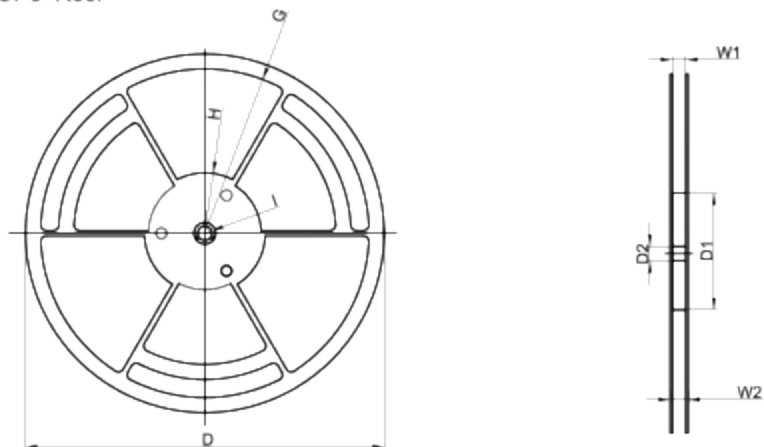

Dimensions are in millimeter								
Reel Option	D	D1	D2	G	H	I	W1	W2
13" Dia	Ø330.00	100.00	13.00	R151.00	R56.00	R6.50	12.40	17.60

REEL	Reel Size	Box	Box Size(mm)	Carton	Carton Size(mm)	G.W.(kg)
2,500 pcs	13 inch	2,500 pcs	336×336×48	20,000 pcs	445×355×365	